

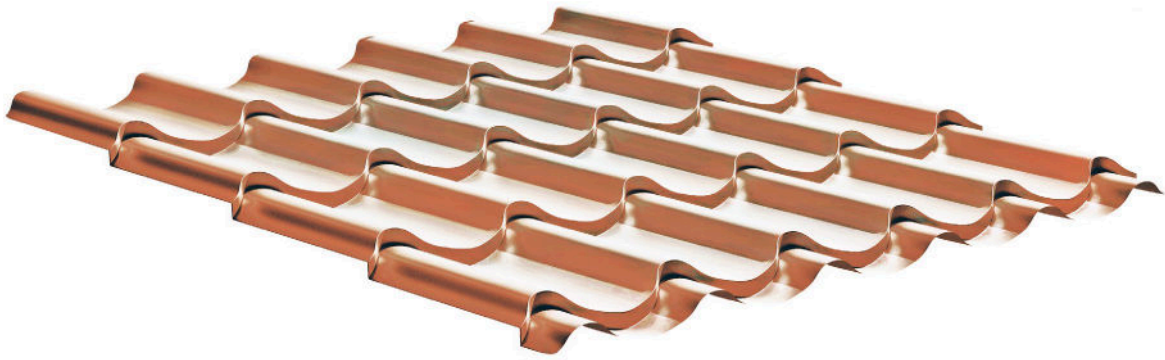

Manufacturers of Florida LLC



SPANISH TILE METAL ROOF PANEL

Product Information & Installation Manual

Version 1.0 - EN-US 2023



COLOPHON

Address and Phone number:

Postal address:

942 Blanche St, Building #3,
Jacksonville, FL 32204, United States

Business hours:

Monday-Friday 7:00 am - 4:00 pm

Internet address:

www.elitesteelflorida.com

E-mail address:

sales@elitesteel.biz

Phone:

(904) 799-6499

Manual info:

The original instructions for this product are provided in the English language and binding. This manual may not be copied, translated, or otherwise reproduced without the permission of Elite Steel Manufacturers of Florida LLC.

History of changes:

Installation Manual Version:	Date:	Chapters:	Description:
V1.0	March 2023	All	First edition



Table of contents

1	PREFACE	4
1.1	IDENTIFICATION	4
2	INTRODUCTION	5
3	SAFETY	6
3.1	Safety Warning Messages in this Manual.....	6
3.2	General Safety Rules for Roof Panel Installation.....	7
3.3	Handling Panels.....	8
3.3.1	Blocking and Banding.....	8
4	SPANISH TILE PANEL OVERVIEW.....	9
5	ROOF DECKING PREPARATION.....	10
6	FASTENERS FOR SPANISH TILE ROOF PANELS.....	11
7	FIELD CUTTING	12
8	FASTENING PATTERNS	13
8.1	Fastening Pattern for NON-HVHZ Construction	13
8.2	Fastening Pattern for HVHZ Construction	14
9	INSTALLATION	15
10	SPANISH TILE FLASHING DETAILS	16
10.1	Eave Drip Detail	17
10.2	High Eave Trim Detail	18
10.3	Valley Flashing Detail	19
10.4	Rake Trim W/ Starter Detail	20
10.5	Sidewall Trim Detail	21
10.6	Endwall Trim Flashing Detail.....	22
10.7	Endwall Reglet Flashing Detail.....	23
10.8	Counter Flashing Detail.....	23
10.9	Rolled Ridge Cap Detail.....	24
10.10	Ridge Ventilation Detail.....	25
10.11	Step Ridge Cap Detail.....	25
10.12	Formed Ridge Cap Detail.....	26
10.13	Hip-to-Ridge Connection Detail	27
10.14	Hip Cap Detail.....	28
11	PIPE BOOT FITTINGS	29
12	CHIMNEY AND SKYLIGHT FLASHING DETAIL	30
13	HELPFUL HINTS.....	31

1 PREFACE

Installation manual for Elite Steel Manufacturers of Florida, LLC Spanish Tile Panel.

This installation manual is the latest, most up-to-date resource on best practices. We provide information, tips and suggestions in this way based on data and knowledge, however these instructions are not a substitute for expert professional advice.

- This manual contains information about product installation and application. The drawings in this manual are for illustration purposes only and may not apply to your specific product installation or building design.
- All projects need to conform to applicable building codes for the area in which they are being constructed. It is recommended to follow all building regulations and standard industry practices.
- Elite Steel Manufacturers of Florida LLC cannot be responsible for the roof system's performance, nor can we assume liability if not installed following the suggested instructions referenced in this manual.
- It is important to verify all the dimensions by field measurements before ordering and installing materials.
- Please direct any questions regarding the installation of Spanish Tile roofing systems to your representative.
- This manual is suitable for installing the Spanish Tile roofing system by Elite Steel Manufacturers of Florida LLC. Consult your representative for any additional information not outlined in this manual.
- The installer is responsible for ensuring the safe installation of this product system according to all guidelines, codes, and regulations of their local building code.

1.1 IDENTIFICATION

Elite Steel Manufacturers of Florida LLC roof tile panels differ from traditional roof tiles in many aspects. Longer lifespan, lightweight, storm resistant, and straightforward installation are just a few unique aspects of these roof tile panels. You can choose from different metal profiles; all profiles are available in various panel lengths and color choices. All the roof facets combine to create a guaranteed optimal match to any architectural style or personal preference. It is a product for years of carefree maintenance.

Metal roof panels provide several benefits that make them a great choice for any home or business. Some of the benefits include:

- **Durability:**
Metal roof panels can last decades and resist weather, pests, and fire damage.

- **Energy Efficiency:**

Metal roofs reflect the sun's ultraviolet rays, which can help keep a building cooler and reduce energy costs.

- **Low Maintenance:**

Metal roofs are extremely durable and require very little maintenance. This durable material can last for years without needing to be replaced like other types of roofing materials.

- **Sustainability:**

Metal roof panels are often made from recycled materials and are fully recyclable at the end of their useful life.

- **Design Flexibility:**

Our metal roof panels come in various styles and colors, making matching any architectural style or personal preference effortless.

Other benefits are:

- Custom ordered to size.
- Resistant to most weather conditions.
- Simple assembly and larger panel coverages reduce the installation time.

2 INTRODUCTION

You must read this manual before installing the Spanish Tile roof panels. The Spanish Tile installation manual will help you understand and appreciate your roof panels. Reading this manual and understanding the Safety and Maintenance instructions will give you better performance and extend the life of your roof panels.

Using This Manual

This Installation Manual is designed to help familiarize you with Safety, Adjustments, Maintenance and Troubleshooting. The information contained within this manual was current at the time of printing. Please check for updates at our website at <http://www.elitesteelflorida.com/> or call to speak with one of our representatives.

3 SAFETY

WARNING!



- Before installing or adjusting, be sure to read and understand all safety measures and warnings.
- It is important that untrained people who have not thoroughly read and understood this manual should not participate in the installation process.

3.1 Safety Warning Messages in this Manual

It is very important to carefully read this manual before installing the roof panels. If there is something in this manual you don't fully understand, please speak with one of our representatives.

- After reading the installation manual, store it in a safe place, easily accessible for roof technicians.
- Improper handling of the roof panels can result in injury or physical damage.
- The manufacturer assumes no responsibility for any damage caused by mishandling the product beyond the standard working method defined in this Installation manual.

DANGER!



- This symbol indicates a potentially and imminently hazardous situation that, if not avoided, will result in death or severe injury.

This RED symbol indicates All DANGER notifications.

WARNING!



- This symbol indicates a potentially hazardous situation that, if not avoided, could result in death or severe injury, or material damage.

This ORANGE symbol indicates All WARNING notifications.

CAUTION!



- This symbol indicates a potentially hazardous situation that, if not avoided, may result in minor or moderate injury.

This YELLOW symbol indicates All CAUTION notifications.

NOTICE:



- This Notice symbol shows special procedures or points out essential facts.

3.2 General Safety Rules for Roof Panel Installation

- Always use extreme caution on a roof, wear gloves, and safety glasses to avoid injury.
- Wear soft-soled shoes to improve traction and minimize damage to the paint finish.
- Ensure the work area is smooth, clean, and free from any obstacles.
- Never stand or walk on any part of a roof panel until it is completely secured.
- Metal panels are slippery when wet, dusty, frosty, or oily. Do not attempt to walk on a metal roof under these conditions. Always use OSHA-recommended safety harnesses or equipment when working on a roof.
- Ensure that all hoisting equipment, such as lifting straps, hooks, or ropes, are in good working condition and are suitable for their intended purpose.
- Always use tools that are in a good working condition. Ensure you know how to use the tools before doing any work.
- Always be aware of your position on the roof relative to any roof openings, roof edges, co-workers, and penetrations.
- **Oil Canning** is defined as the perceived waviness of a metal panel and is an inherent characteristic of light-gauge, cold-rolled flat metal products. In other words, it's a visual phenomenon that makes metal panels look wavy or somewhat distorted, especially in a metal roof system's broad, flat areas. Improper moving, twisting, and handling of panels can allow for more oil canning opportunities.

Storage:

- Always inspect panels for moisture accumulation. If moisture has formed, the panels should be unbundled, wiped dry, and allowed to dry completely. Once dry, carefully restack the panels and loosely cover them, allowing for ample air circulation.
- Bundled sheets should be stored high enough off the ground to allow air circulation and prevent contact with accumulating water.
- We recommend covering the bundle with a tarp.
- It is important not to use tightly wrapped plastic as a cover for the bundle as it can delay necessary ventilation and retain heat and moisture, accelerating metal corrosion.
- It is not recommended to store the panels in a bundle for extended periods of time.
- Under no circumstances, should you store the panels near or where they encounter salt water, corrosive chemicals, ash, or fumes released inside the building or from nearby factories such as foundries, rolling mills, and fertilizer kilns.

3.3 Handling Panels

WARNING!



- Improper loading/unloading of bundles and crates may result in bodily harm and/or material damage. Elite Steel Manufacturers of Florida LLC assumes no liability for personal injuries and material damages resulting from improper handling of materials.

- Never pick up long panels horizontally at their ends.
- Lift panels at the edge when moving.
- Avoid dragging panels, it will cause scratching and scouring to the coated surface.
- Depending on the panel size, two or more persons should handle the panels.

INCORRECT METHOD



CORRECT METHOD



3.3.1 Blocking And Banding

Elite Steel Manufacturers of Florida LLC utilizes this method for standard packaging of roofing panels. Panels are stacked on a wooden skid and protected with a cover sheet, then banded around the wooden skid to hold the panels tightly in place.



4 SPANISH TILE PANEL OVERVIEW

Elite Steel Manufacturers of Florida LLC Spanish Tile panel is designed to create a curved, Spanish-like shape when installed on a roof. The curved shape of the Spanish Tile panel allows water to flow easily off the roof.

Slope:

The minimum recommended slope for Spanish Tile panel is 3:12.

Substrate

Typical roof sheathing from Elite Steel Spanish Tile panels can be installed over include 7/16" OSB, 1/2" Plywood, 5/8" Plywood and 3/4" Plywood.

Width Coverage

Each panel has a width coverage of 39 11/16".

Length

- The minimum factory cut length is 2'- 0".
- Maximum panel length is 46'- 0".
- Lengths between 2'- 0" and 46'- 0" will be cut at 6" increments.

Application

Spanish Tile panels are installed vertically from the eave to the ridge and from right to left. You should always walk on the high rib of a panel where a step is located and always wear soft-soled shoes.

Fasteners

Please refer to the paragraph 'Fasteners' in this Manual for choosing proper fasteners for specific applications.

- The quantity and type of fastener must meet the necessary loading and code requirements.

Materials

Elite Steel Manufacturers of Florida LLC Spanish Tile panels are manufactured with 24ga, 26ga, 29ga, and .032 Aluminium.

Finishes

Elite Steel Manufacturers of Florida LLC Spanish Tile panels are available in limited Fluorocarbon (PVF2) finishes. It stands for Polyvinylidene fluoride and is a thermoplastic fluoropolymer. The coating is an acrylic resin. It meets the specifications of the Kynar 500 and Hylar 5000. Also offered is SMP finishes. SMP stands for 'Siliconized Modified Polyester,' a type of paint used on metal roofs to protect them from the elements. SMP coatings are made by combining polyester resin with silicone, which creates a durable and weather-resistant finish.

Spanish Tile Isometric picture with dimensions

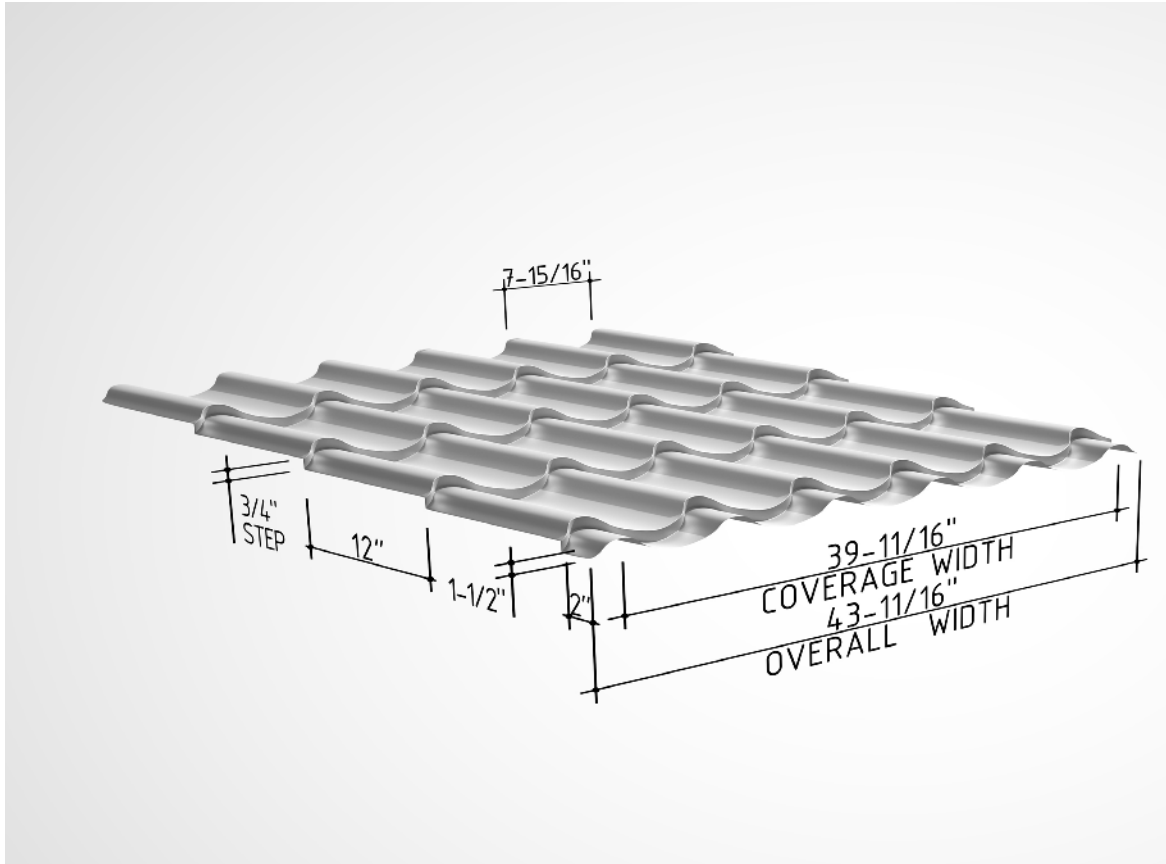

5 ROOF DECKING PREPARATION

Before installing Spanish Tile panels, it's essential to prepare your roof deck properly to ensure that the metal panels will be installed correctly. To ensure that you are following proper installation guidelines, remove all old roofing materials and inspect the roof deck for any damages or protruding fasteners that would hinder the proper installation of new metal panels. Ensure all roof surfaces are clean, level, and free of imperfections. Please make sure the roof deck complies with your local building codes.

6 FASTENERS FOR SPANISH TILE PANELS

IMPORTANT WARNINGS!

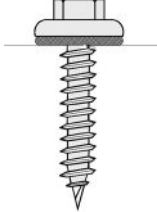
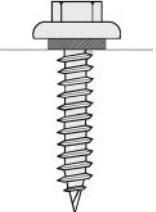
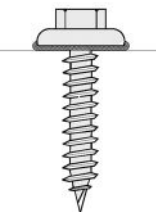

- **RECOMMENDED TOOL TYPE** - Use a depth-locating nose or adjustable clutch on the screw gun to prevent over-drilling and stripping.
- **ALL FASTENERS MUST BE INSTALLED STRAIGHT, NOT AT AN ANGLE.**
- **SEATING THE WASHER** - Apply sufficient torque to seat the washer - do not overdrive the fastener.
- **TO PREVENT WOBBLING** - Ensure the fastener head is fully engaged in the socket.
- **Metal shavings may build up from drilling and should be removed occasionally.**

<p>CORRECT The sealing material is slightly visible at the edge of the metal washer. The assembly is watertight.</p>	<p>TOO LOOSE The sealing material is not visible; not enough compression to seal correctly.</p>	<p>TOO TIGHT Metal washer deformed; sealing material pressed beyond washer edge.</p>
		

7 FIELD CUTTING

WARNINGS!



- **All surfaces should be free of debris.**
- **Installed surfaces should be wiped clean at the end of each work period.**
- **Never cut panels over metal surfaces.**
- **Metal shavings will rust on the surface, voiding the warranty.**

When cutting or trimming panels, we recommend using a large metal hand shears, power shears, or nibblers.

- To avoid damage to the paint and zinc coatings, never use abrasive metal discs under any circumstances. These types of cutting tools produce heat which could cause the paint and zinc coatings to lose adhesion.
- Please be advised that raw metal shavings will oxidize and rust on the paint coating causing permanent damage. This is not covered by the paint warranty.

8 FASTENING PATTERNS

8.1 Fastening Pattern for NON-HVHZ Construction

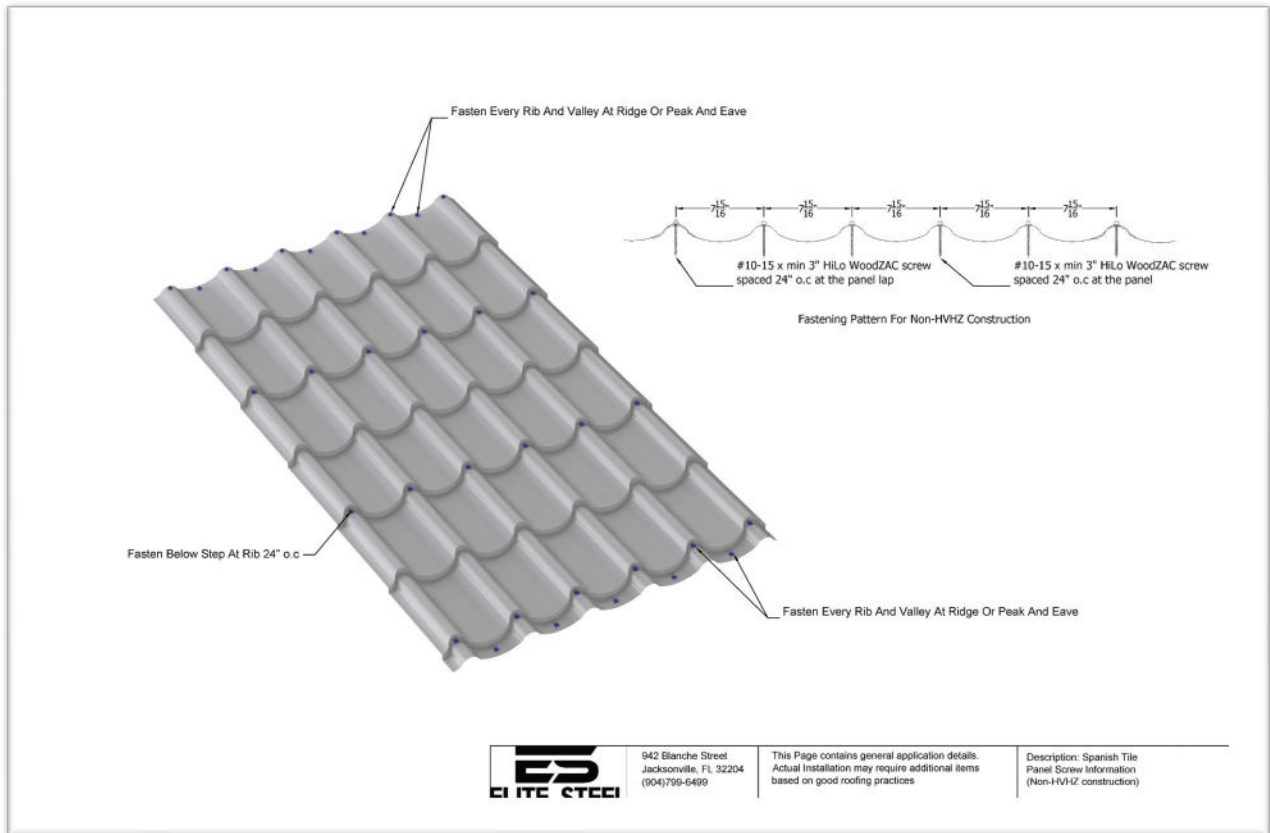

8.2 Fastening Pattern for HVHZ Construction

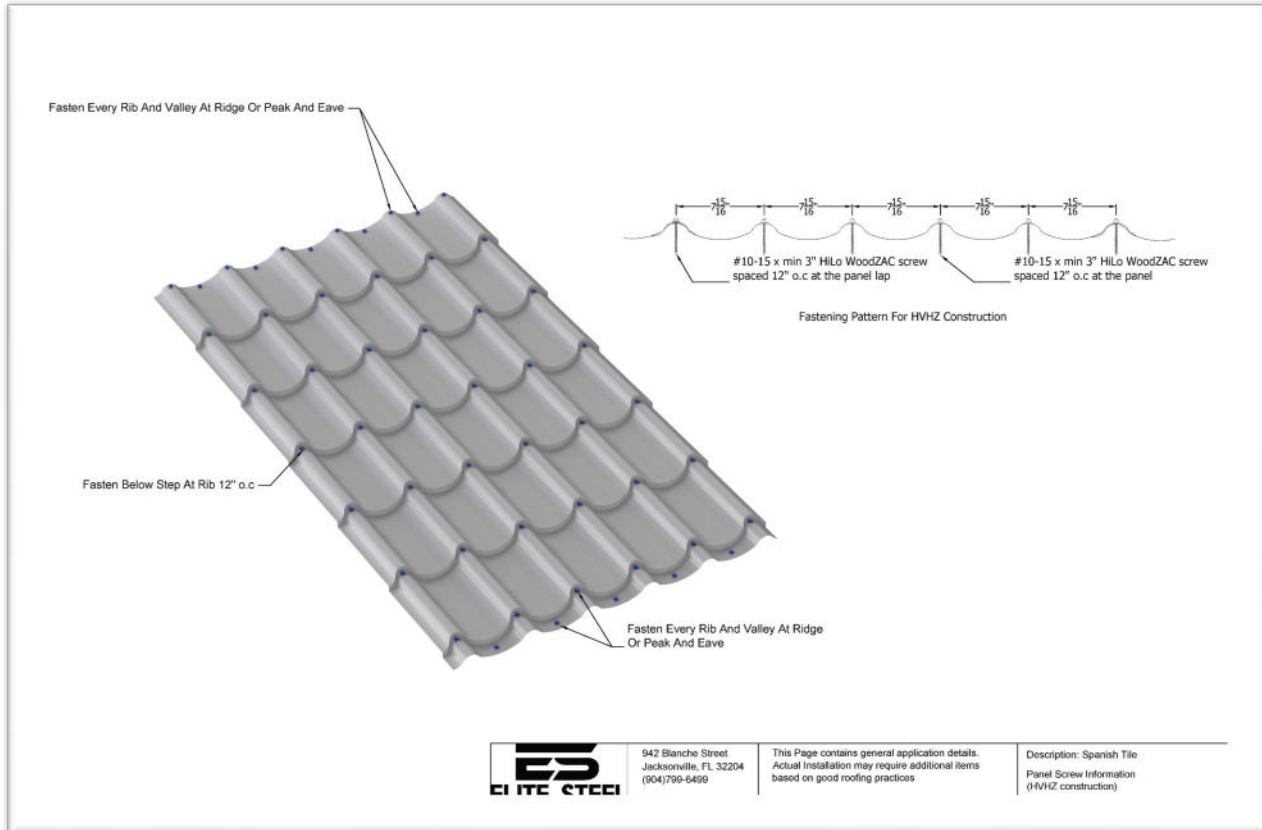

9 INSTALLATION

Before installing the Spanish Tile panel, the eave drip and valley flashings must be installed. The Elite Steel Spanish Tile panel has exposed fasteners that has a coverage width of 39 11/16 inches and can be custom cut to lengths ranging from 2 to 46 feet. Panels longer than 46 feet require additional consideration in packaging, shipping, and erection. Spanish Tile panels are installed vertically from the eave to the ridge and from right to left. With the first panel placed over the inside closure foam. The bottom edge of the panel should overhang the eave-line by ½ inch. The additional panels overlap by one corrugation as they progress to the left.

Squareness is essential

The critical point of the panel layout is at the eave line. Always align the panels with the eaves. It is important that the panels are installed straight along this line, as any deviation from squareness can lead to problems with the panel installation and the performance of the roof. When installing the first three panels, use only a few screws to hold them in place. This allows you to adjust before the panels are fully secured to the deck. To ensure squareness, checking every third panel during installation is advisable. Once the panels are aligned properly and the straight line is maintained, you can secure the panels in place.

Care should be taken when handling panels and should be supported or carried on edge to avoid bowing the panel. Improper handling of the panels during installation may result in small gaps on the sides near the tile steps. It is recommended that any such gaps be caulked with an approved silicone-based weather resistant sealant. This will minimize any possibility of water intrusion at the side-lap.

10 SPANISH TILE FLASHING DETAILS

This section shows drawings of the most common flashing details. The details presented may not apply to all conditions or designs. If you have any questions, please contact one of our representatives.

Flashing Overview:



10.1 Eave Drip Detail

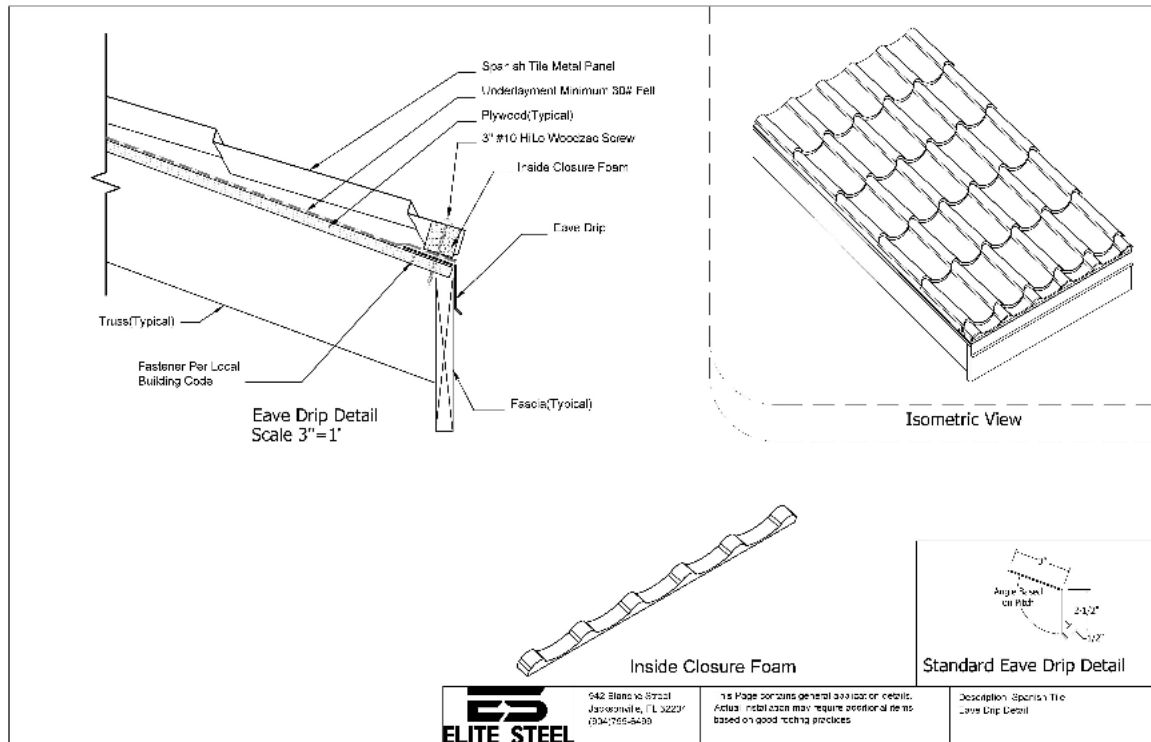

Eave Drip Description

The eave drip is installed in a straight line at the eave and should be attached prior to installation of the roof panels. The minimum overlap of each piece of eave trim must be 4-inches and installed per local building code.

10.2 High Eave Trim Detail

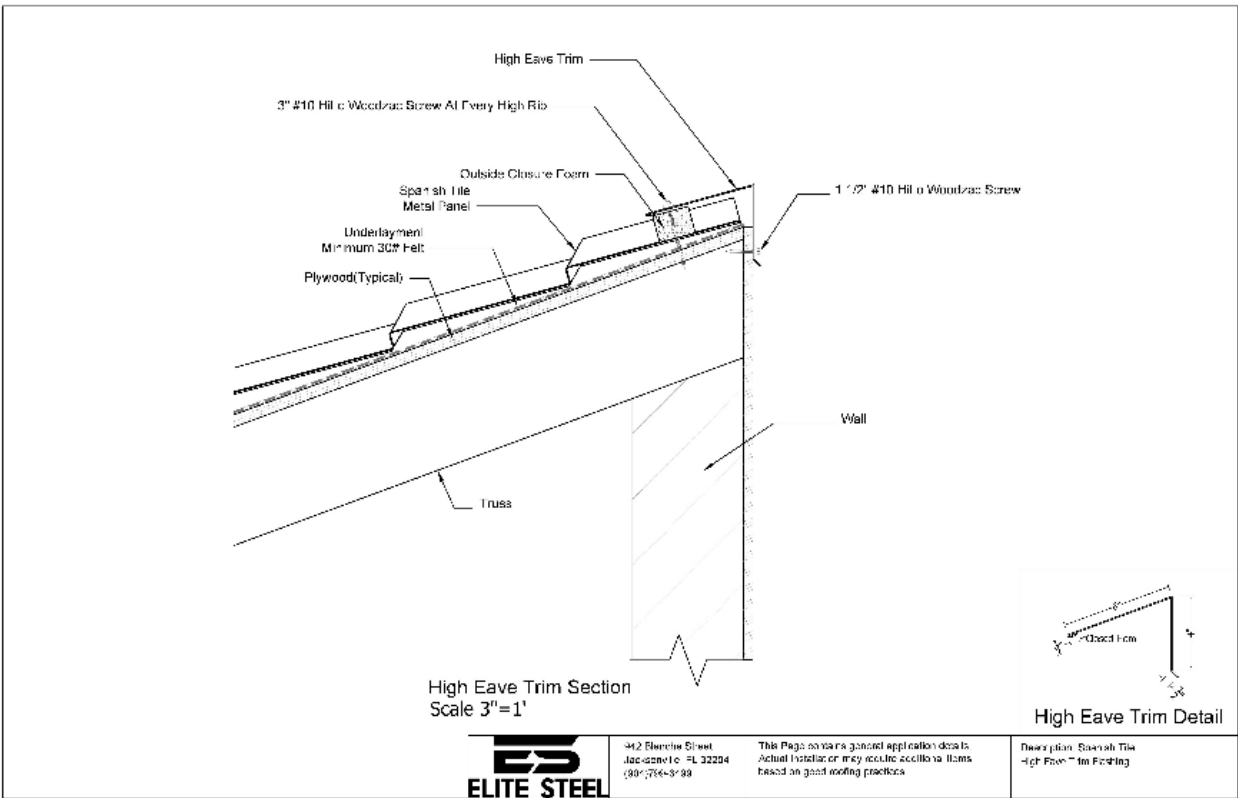

10.3 Valley Flashing Detail

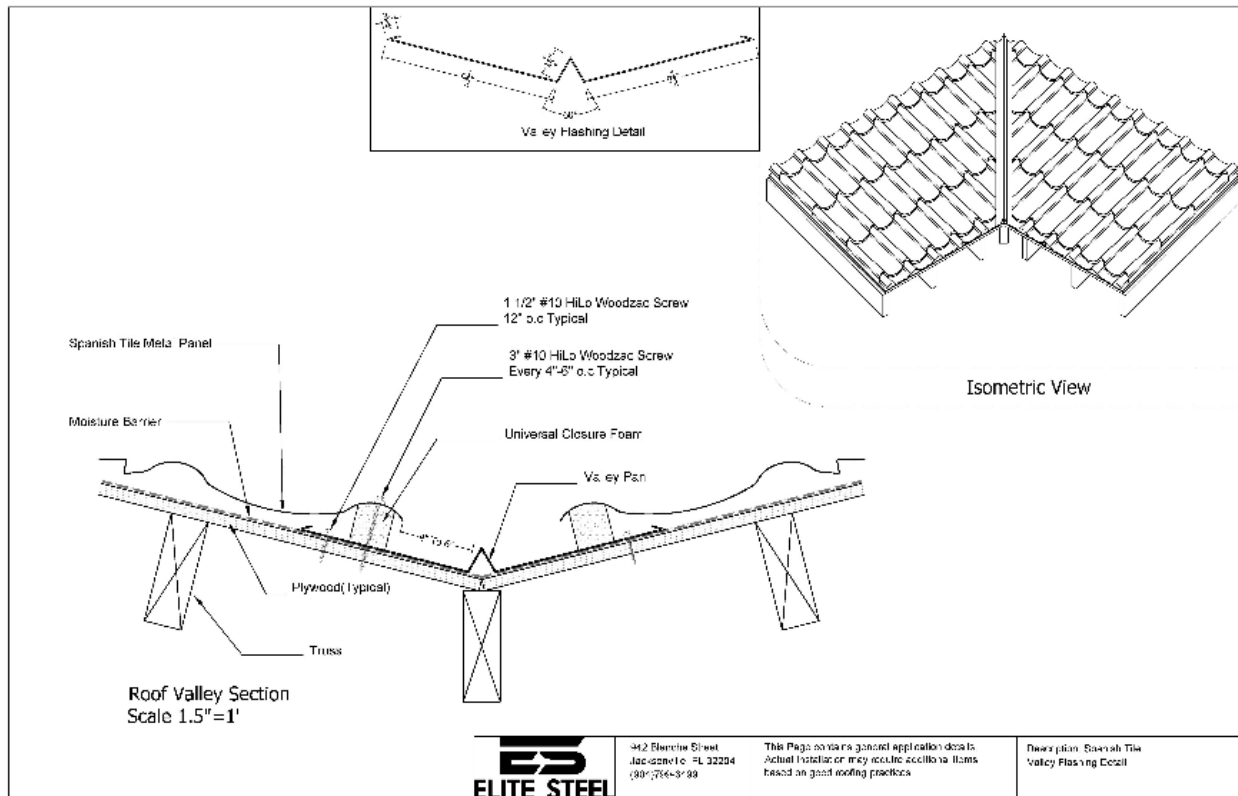

Valley Flashing Description

Valley flashing is one of the most critical flashing components of a metal roof system. It helps divert the water off the roof where two roof planes meet. It is recommended to install an ice and water shield in the center of the valley to provide a layer of protection against water infiltration. The valley flashing has an inverted V shape in the middle of the pan.

The first section of valley flashing is installed at the eave line overhanging 3"-4" inches and field cut as needed. Each subsequent section of valley flashing must overlap a minimum of 6 inches, working toward the ridge. A silicone sealant should be applied at the overlapped area between the valley flashing. Cut the bevel of the underlying valley flashing to help maintain the valley to be installed straight and level. Secure the valley flashings with 1 1/2" #10 screws every 1' to 2' just inside the valley pan on both sides, follow your local building code. Install a universal closure foam 2" wide x 2" high, 4"-6" from the valley's centerline. It is recommended to install a bead of silicone sealant on the top of the universal closure before panel installation. Install the roof panels 3/8" of an inch overhanging the closure foam. Fasten the roof panels 4" to 6" on center on the valley. These screws will penetrate the roofing panel, sealant, universal foam, valley pan, and substrate.

10.4 Rake Trim W/ Starter Detail

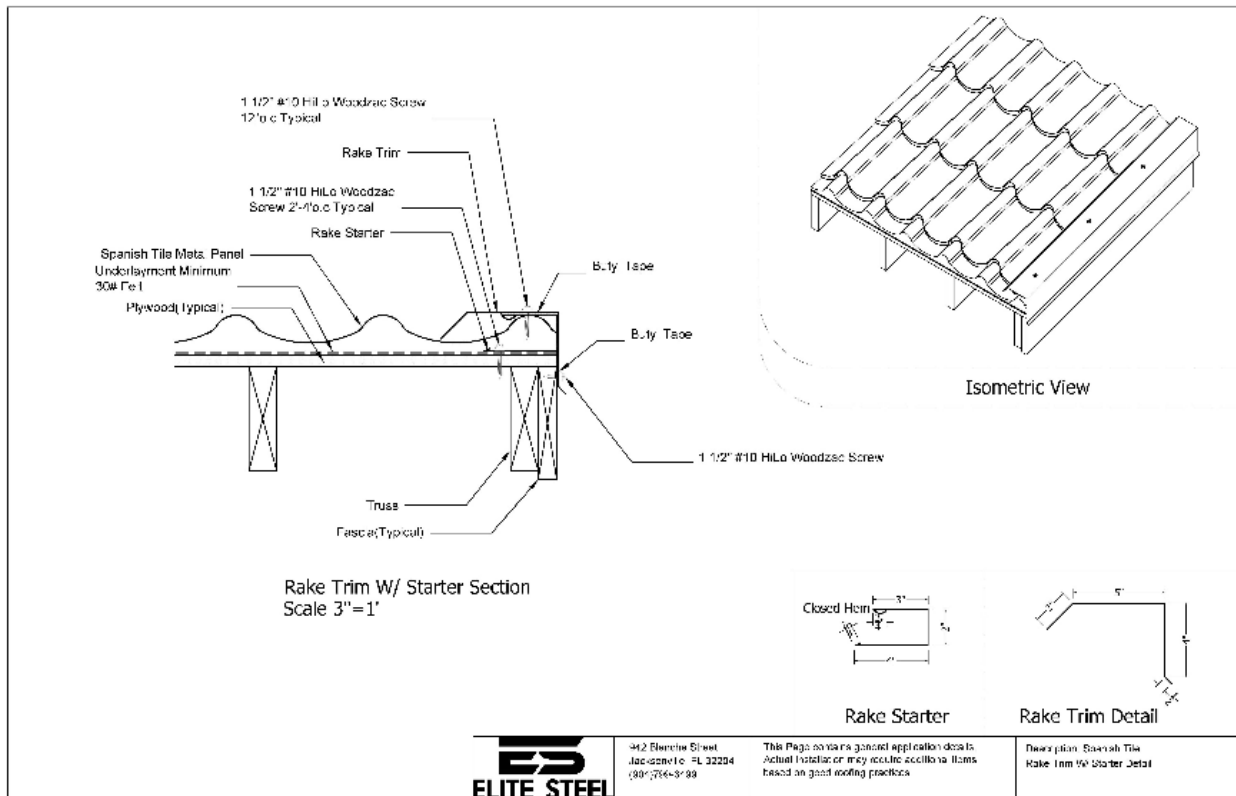

Rake Trim W/ Starter Description

Installing rake trim and a rake starter on a metal roof creates a finished and professional look to the roof's edge. Install the rake starter at the roof's edge, ensuring it's flush with the eave drip. Fasten the rake starter using 1 1/2" #10 screws 1' - 3' on center. Install the Spanish Tile panel inside the rake starter. Extend the rake trim past the eave line by 2" for the rake trim to create a return of 90 degrees so the rake trim can be boxed or closed off. Fasten the rake trim using a 1 1/2" #10 screw 1' - 4' into the rake starter and fastened to the fascia. Overlap consecutive trim pieces by 4 inches, minimum up the rake and apply a silicone sealant at the overlapped area. Use Butyl tape on the bottom edge of the rake trim at the fascia attachment.

10.5 Sidewall Trim Detail

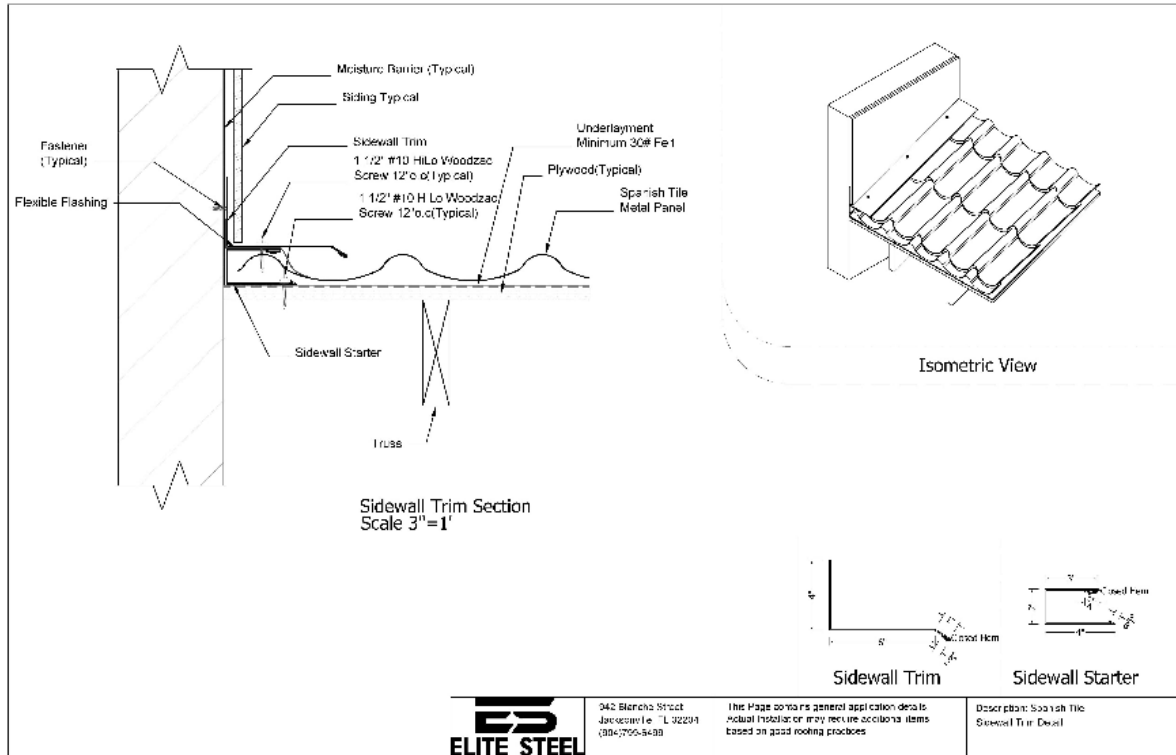

Sidewall Trim Description

Elite Steel Spanish tile panels require sidewall trim and starter at all roof-to-wall junctions where the side of the panel meets a vertical wall. The sidewall starter is installed along the base of the vertical wall and installed with 1 ½" #10 screw 1' – 3' on center, or per local building codes. Install the Spanish Tile panel inside the sidewall starter. Apply flexible flashing along the edge of the panel, over the sidewall starter, and secure it to the vertical wall. The sidewall trim is then placed on top of the sidewall starter, the Spanish tile panel, and attached to the vertical wall using standard building practices. Fastening for the sidewall trim requires using a 1 ½" #10 screw attached to every other high rib, or per local building code.

10.6 Endwall Trim Flashing Detail

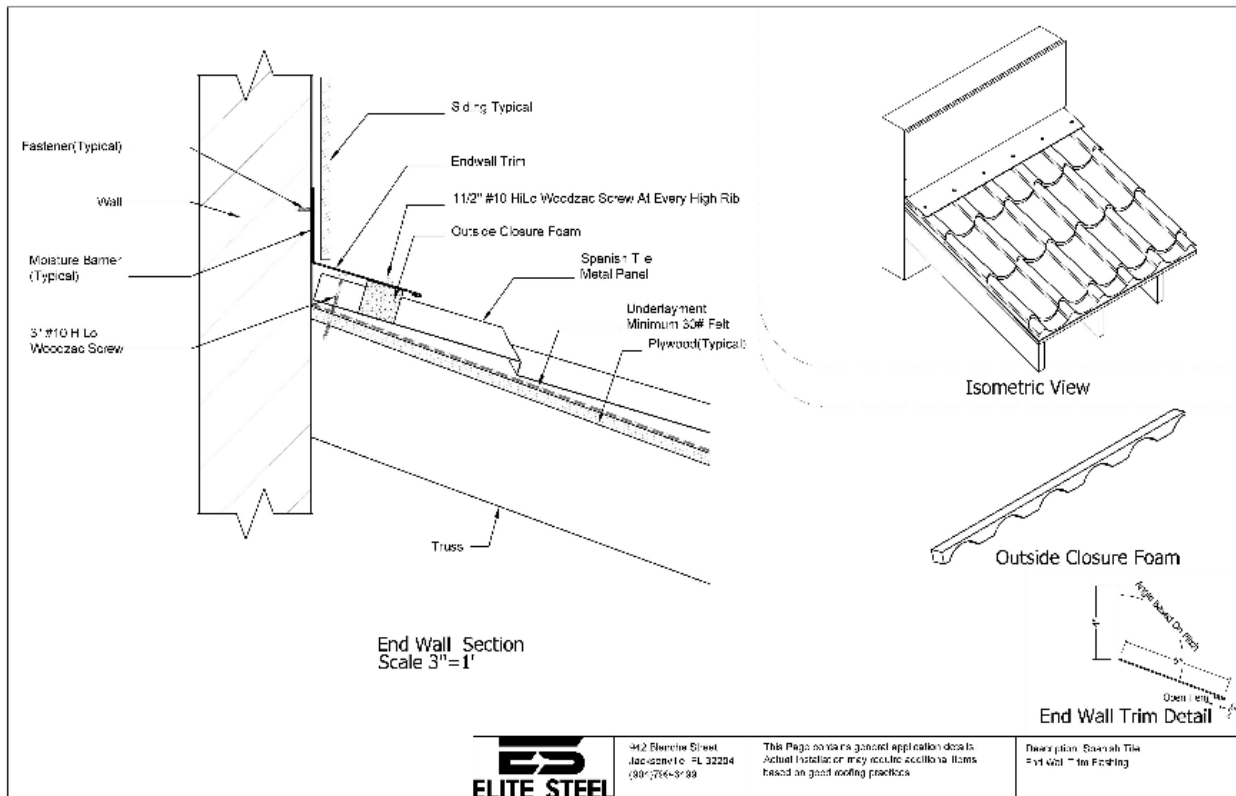

Endwall Trim Description

Elite Steel Spanish Tile panel requires endwall trim at all roof-to-wall junctions where the panel meets a vertical wall. Use standard building practices to install the endwall trim on top of the Spanish Tile panel and secure it to the vertical wall. To ensure a water-tight seal, install our custom outside closure foam strip in-between the endwall trim and roof panel. Fastening for the endwall trim requires a 1 1/2" #10 screw attached to every high rib, or per local building code. Carefully inspect the endwall trim to ensure it is securely fastened and there are no gaps or cracks where water could enter.

10.7 Endwall Reglet Flashing Detail

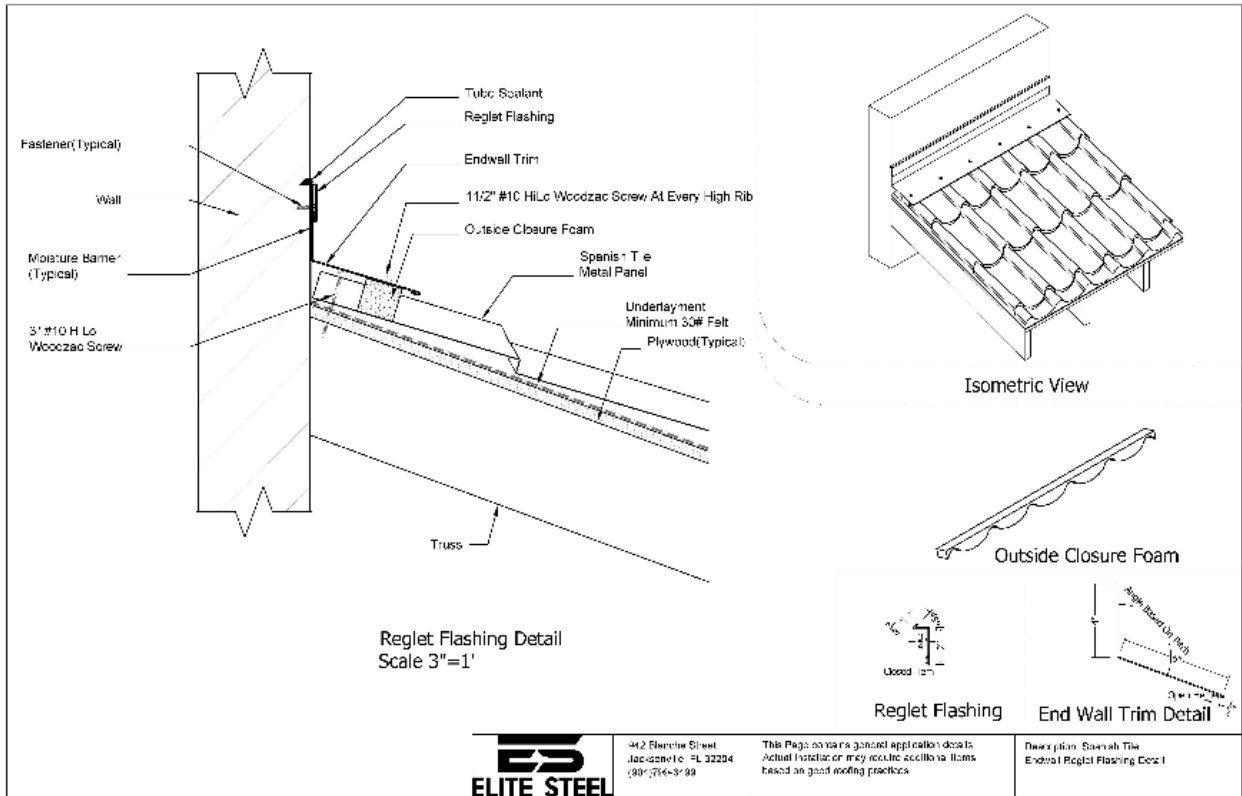

10.8 Counter Flashing Detail

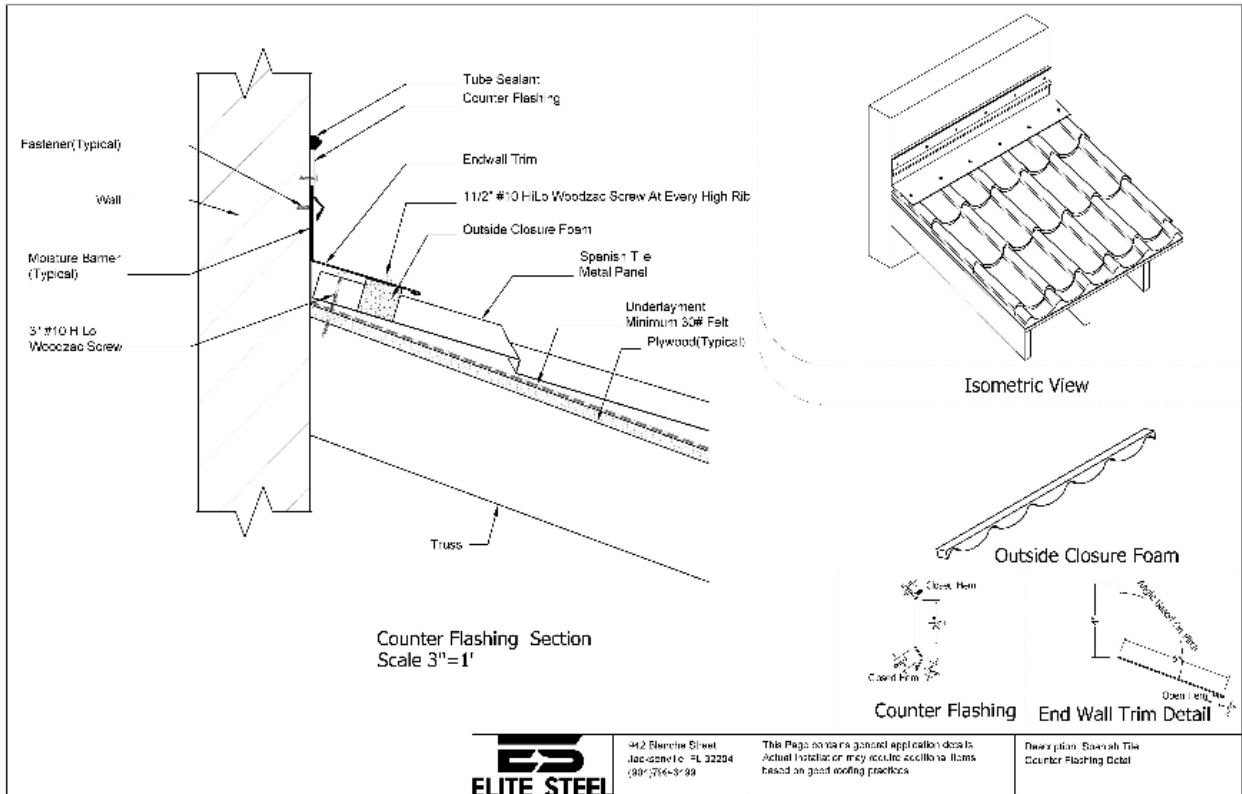

10.9 Rolled Ridge Cap Detail

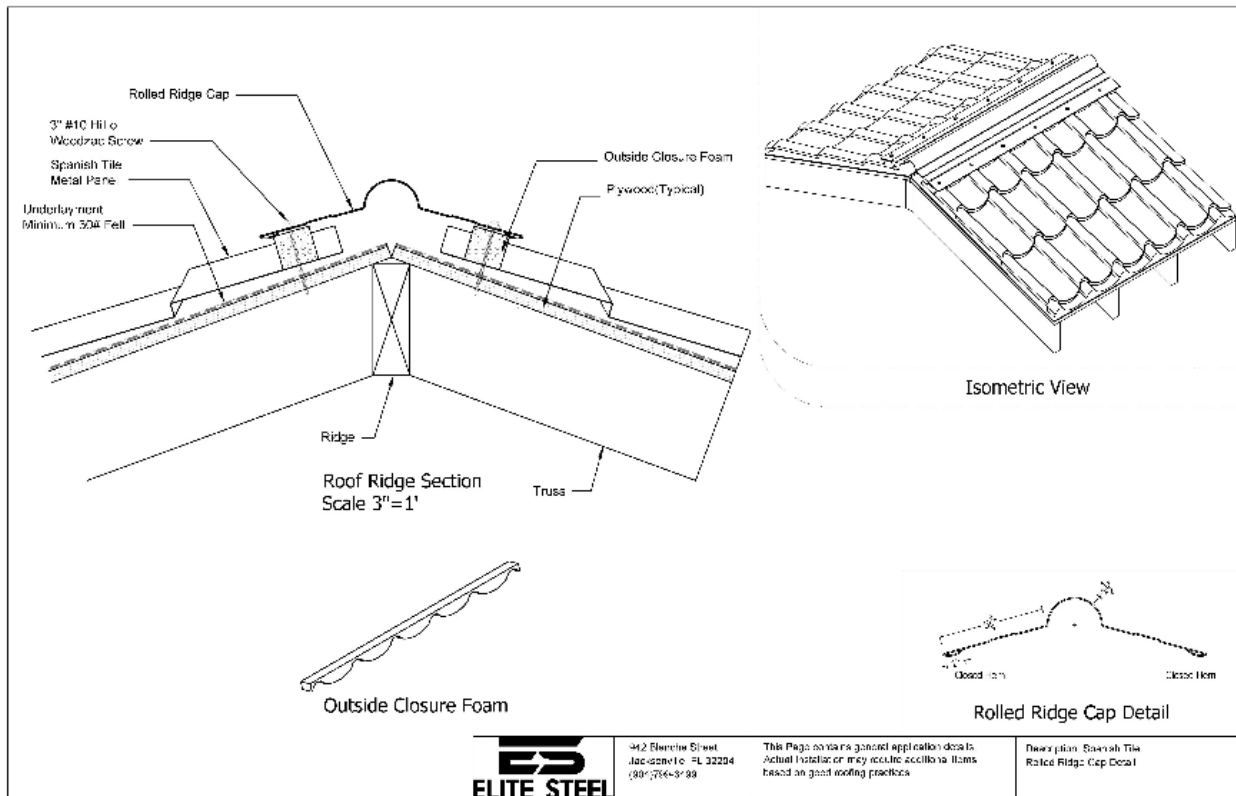

Ridge Cap Description

Elite Steel offers three types of ridge caps for Spanish Tile panels; step ridge cap, formed ridge cap, or rolled ridge cap. Step and rolled ridge caps come standard in 10' lengths and formed ridge cap comes standard in 9' 6" lengths. The step ridge cap has a width of 14". The rolled ridge cap has a width of 13 1/4". The formed ridge cap has a width of 15".

The ridge cap must be centered over the ridge line and aligned with the roof panels. Install our custom outside closure foam strip in-between the ridge cap and roof panel. Fasten the ridge cap using 3" #10 screws on both sides. Screws should be fastened minimum at every other high rib, or per local building code. If the install location is in areas prone to high wind, fasten the screw through every high rib. Install consecutive ridge caps with a minimum of 4-inches lap, and apply a silicone sealant at each overlap to ensure a water-tight seal. If ventilation is needed at the ridge, including the EZ Vent-n-closure system. See the following detail.

10.10 Ridge Ventilation Detail

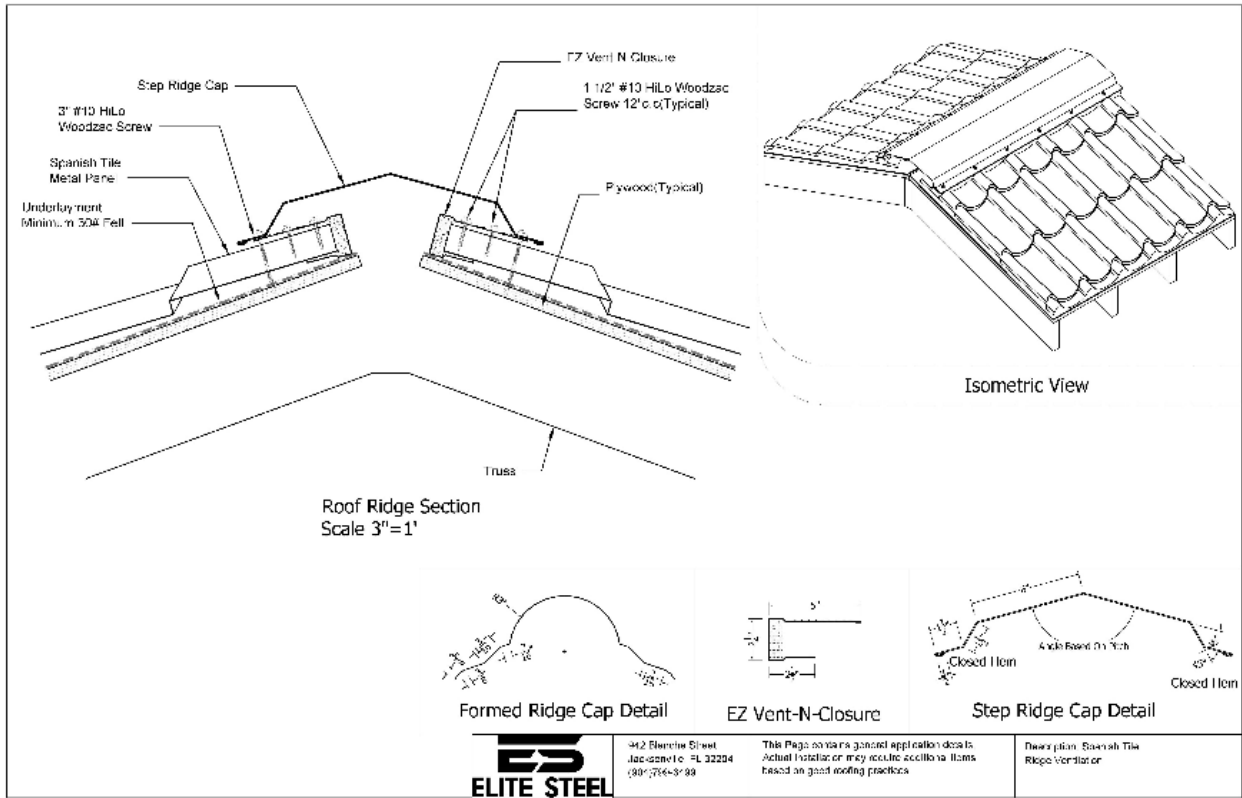

10.11 Step Ridge Cap Detail

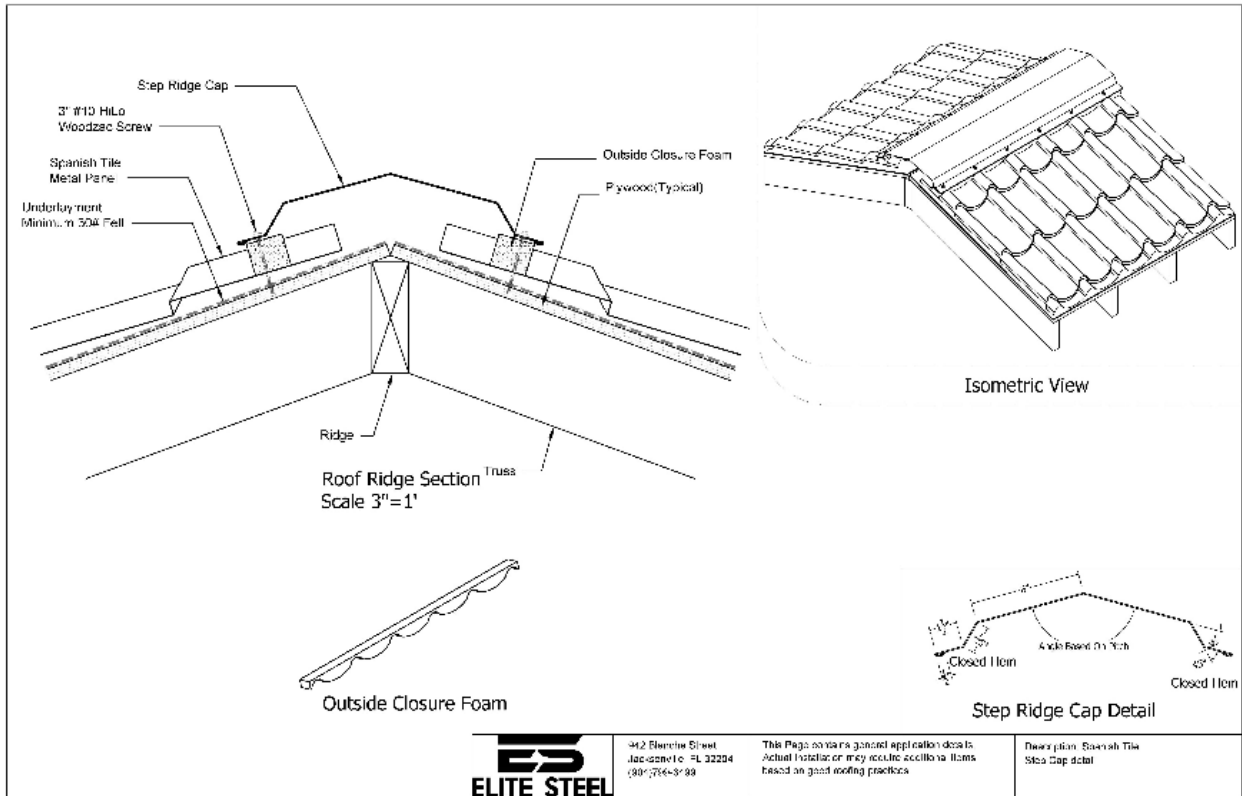

10.12 Formed Ridge Cap Detail

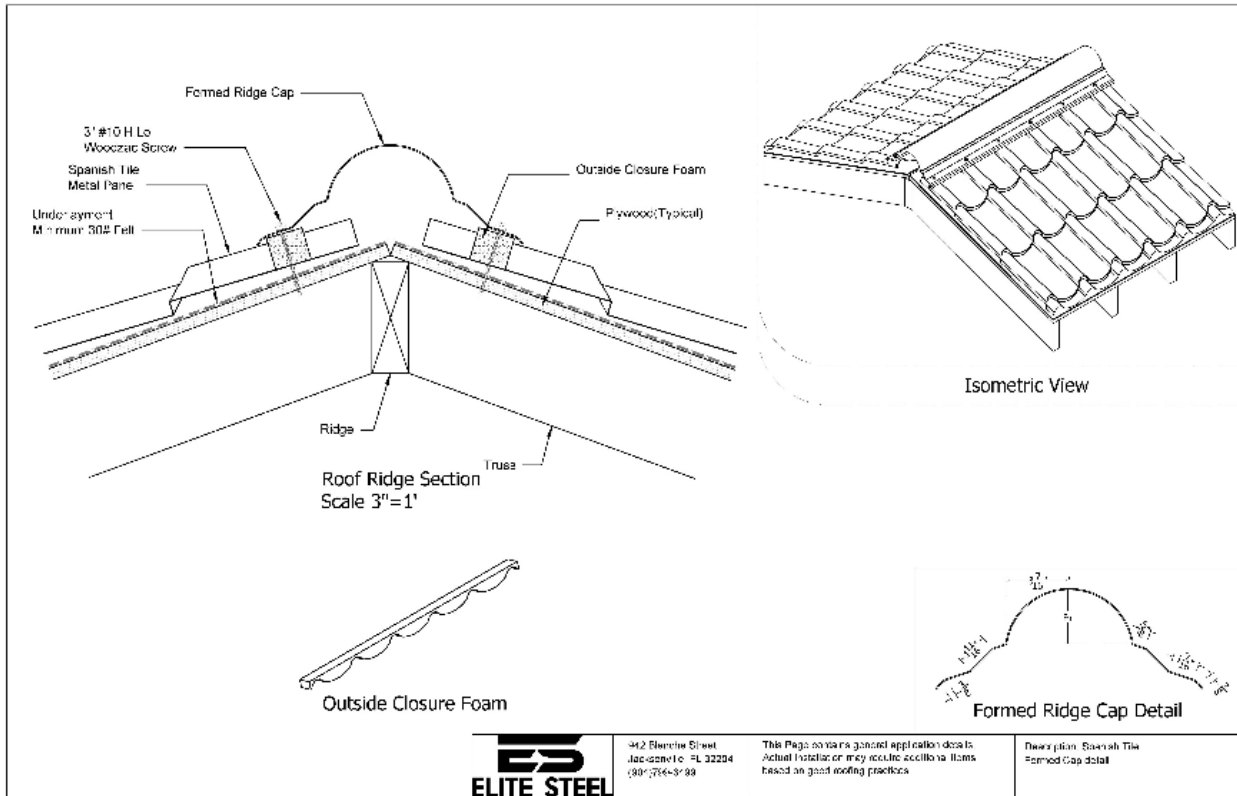

10.13 Hip-to-Ridge Connection Detail

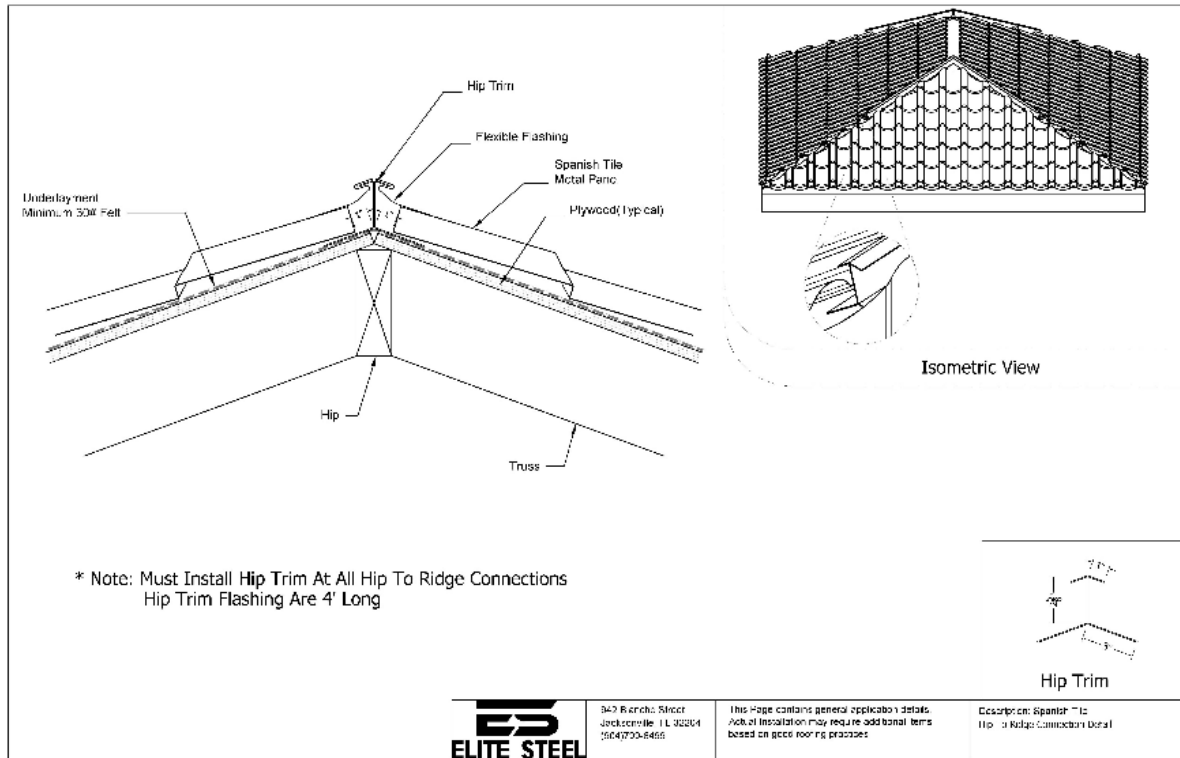

Hip-to-Ridge Description

The Hip Trim is an important component of the Spanish Tile panel installation that helps prevent water intrusion where the hip and ridge lines intersect. The 4' hip trim flashing is installed between the roof panels on the hips of the roof where they meet the ridge. The Spanish Tile panels are cut to match the angle of the hip and installed on the deck.

10.14 Hip Cap Detail

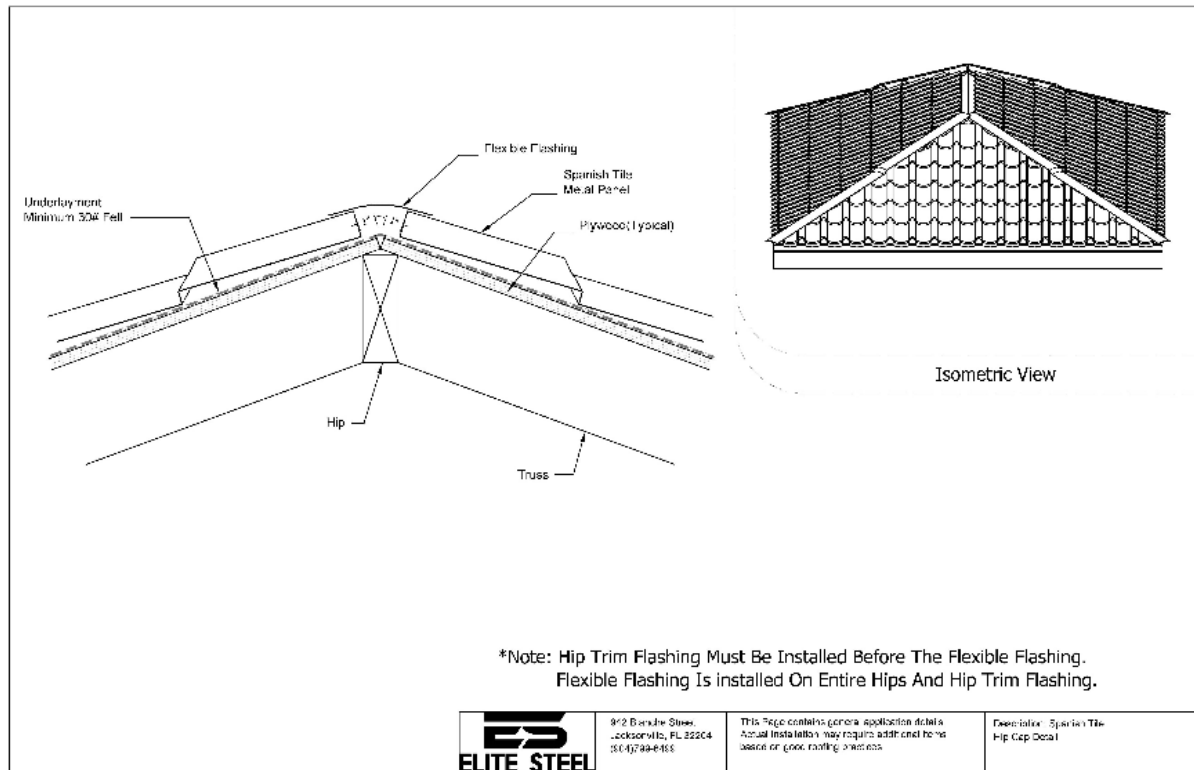

Hip Cap Description

Note: The Hip Trim flashings must be installed before the flexible flashing. The flexible flashing is centered over the hip and installed by pressing and tucking around the hip trim, down, and onto the panels. Always press the outside edges of the tape to conform to the roof panel. The flexible flashing is also installed over the panels at hip locations and conformed to the structure of the Spanish tile panel. Use the flexible flashing in all hip locations.

Before installing the hip cap, first apply butyl tape on the bottom of the hip cap. Extend the first hip cap 8 inches past the end of the hip. Cut and fold the hip trim to close off the end or install a custom end cap trim piece. Fasten the hip cap with 3" #10 screws on both sides at every other high rib, or local building code. Install consecutive hip caps with a minimum of a 4-inch lap and apply silicone sealant at each overlap to ensure a water-tight seal.

11 PIPE BOOT FITTINGS

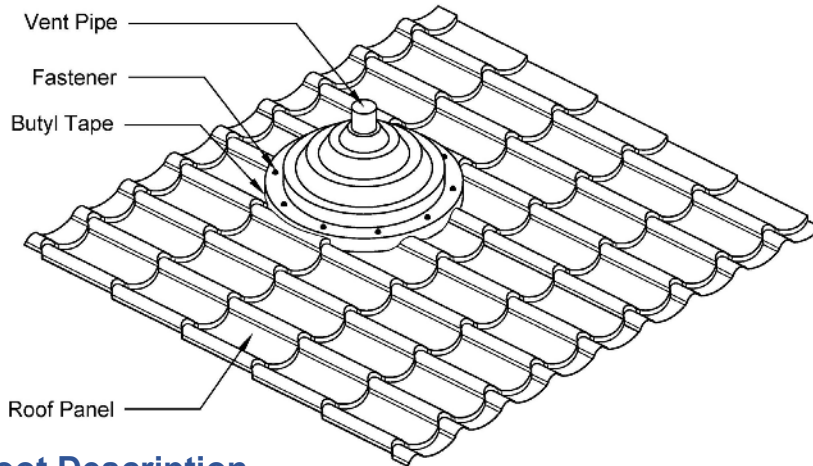

Pipe Boot Description

It is important to note that these instructions are general guidelines, and it is always best to follow the specific instructions and recommendations of the manufacturer of the flashing boot and roofing material. Install an approved metal roofing pipe boot. This will typically be made of pliable material, such as rubber or EPDM.

Slide the pipe boot down the pipe until it rests on the roof surface. If necessary, use water to lubricate the sleeve, making it easier to slide down. Form and bend the base of the flashing boot to match the contours of the metal roofing panel. It will help ensure a tight seal around the pipe. Apply Butyl tape between the flashing boot and the metal roofing panel. Be sure to cover the entire area where the flashing boot meets the panel. Fasten the flashing boot to the Spanish Tile panel using approved fasteners. Place the fasteners 2" to 3" apart to create a water-tight seal.

Retro flashing boots are designed to provide a water-tight seal around pipe penetrations, such as electric service poles, where access from the top is not possible or practical. These boots typically have a split design that allows them to be wrapped around the pipe and secured with snap rivets and a sealing band. This product is typically available in various sizes to accommodate different pipe diameters.

12 CHIMNEY AND SKYLIGHT FLASHING DETAIL

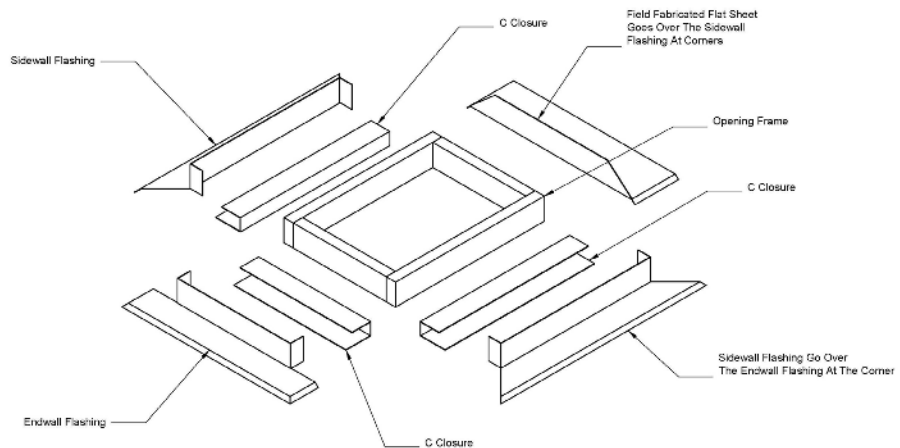
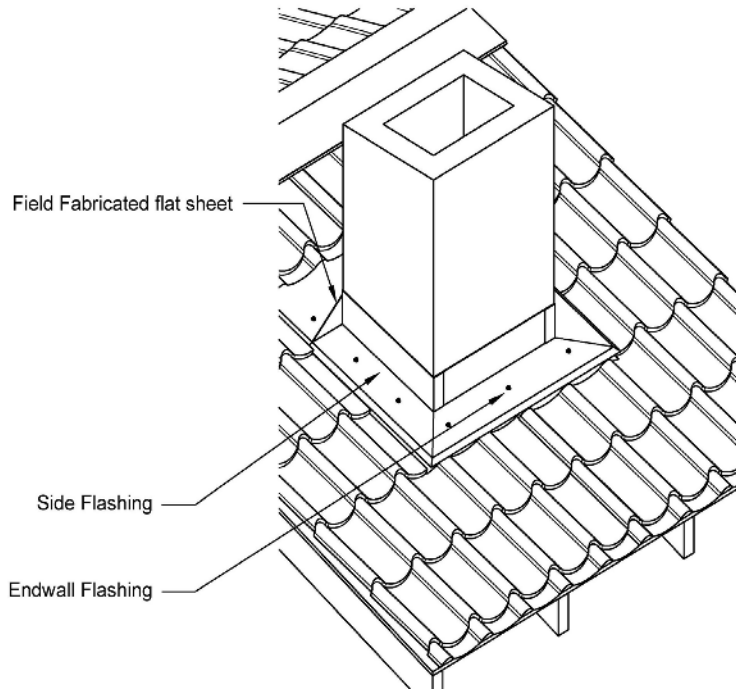

Roof Opening Flashing Detail

Chimney and Skylight Flashing Description

Install C-closure trim flashings on the two sides and bottom. Install the Spanish Tile panels inside the C-closure. Apply flexible flashing along the edge of the panel, over the C-closure, and secure it to the wall of chimney/skylight. The endwall trim is then placed on the bottom side of the chimney/skylight over the C-closure and Spanish Tile panel. Cut and bend the endwall trim around the sides of the chimney/skylight. Then install the

sidewall trim to the sides of the chimney/skylight, so they will overlap the endwall trim. Cut and fold the ends of the sidewall trim. Apply silicone sealant at all overlaps.

Always use a field fabricated flat sheet on top of chimney/skylights. Make sure you cut the Spanish Tile panel at the top of the chimney/skylight to allow room to install the flat sheet. The fabricated flat sheet must go underneath the Spanish Tile panel. If the chimney/skylight is wider, a cricket must be installed, and 2 or more field fabricated flat sheets may be needed. Install closure foam in-between the panel and fabricated flat sheet. Cut the vertical ends of the flat sheet at an angle and make sure they extend over the high rib of the Spanish Tile panel on both sides of the chimney/skylight. The fabricated flat sheet goes over the sidewall trim at the corners.

13 HELPFUL HINTS

1. Keep the Spanish Tile panels dry and well-ventilated when subjected to wet conditions.
2. Please use caution, Spanish Tile panels become extremely slippery when wet.
3. Best practices use a working foam mat during installation.
4. All Spanish Tile panels and accessories should be installed in accordance with local building code. As always, good tradesperson practices should be followed when installing this product.
5. To prevent possible damage to the panel, you should always walk on the high rib of a panel where a step is located and always wear soft-soled shoes.
6. All painted panels and flashings have a factory applied baked-on finish. Handling and installing panels may result in some small scratches or nicks to the paint finish. Touch-up paint is available in matching panel colors.
7. Panels should be handled carefully to prevent damage. Never pick up long panels horizontally at their ends. Always lift panels at the edge when moving. Avoid dragging panels, it will cause scratching and scouring to the coated surface. Lift panels at the edge when moving. Depending on the panel size, two or more persons should handle the panels.
8. Use a tool with a depth-locating nose or adjustable clutch on the screw gun to prevent over-drilling and striping. All fasteners must be installed straight, not at an angle. Seating the washer- apply sufficient torque to seat the washer - do not overdrive the fastener.
9. When cutting or trimming, we recommend using large metal hand shears, power shears, or nibblers. Never use abrasive metal discs under any circumstances. The heat

caused by this method of cutting can cause the paint and zinc coatings to lose adhesion, and the raw metal shavings will oxidize and rust on the coating causing permanent damage. This is not covered by the paint warranty.

- 10.** To reduce installation time, pre-drill Spanish Tile panels at the required screw locations on the ground before installing panels on your roof.